

MOWER

INSTRUCTION BOOK

Models
22" Push

This Instruction Book contains information for several models. Read and keep this book for future reference. This book contains important information on **SAFETY, ASSEMBLY, OPERATION, AND MAINTENANCE.**

PRODUCT INFORMATION

The owner must be certain that all the product information is included with the unit. This information includes the INSTRUCTION BOOKS, the REPLACEMENT PARTS and the WARRANTIES. This information must be included to make sure state laws and other laws are followed.



RECORD THE FOLLOWING INFORMATION ABOUT YOUR UNIT. THIS INFORMATION IS NECESSARY WHEN ORDERING PARTS OR IN CASE OF LOSS OR THEFT.

WHERE PURCHASED: _____.

DATE PURCHASED: Month _____ Day _____ Year _____.

MODEL NO.: _____ DATE OF MANUFACTURE: _____.



F-030401L

MURRAY, INC. Two Year Limited Warranty

Murray, Inc. warrants to the original purchaser that this unit shall be free from defects in material and workmanship under normal use and service for a period of **Two (2) Years** from the date of purchase; however, this warranty does not cover engines, accessories (such as snow blowers, snow blades, grass baggers and plows), transmissions, batteries and Normal Wear Parts (except as noted below) or transaxles as the companies that manufacture these items furnish their own warranties and provide service through their authorized field service facilities. For additional information, see the warranties covering these particular parts. If you are uncertain whether your unit contains or is equipped with one or more of these parts, consult your dealer prior to purchase. Subject to the terms and conditions noted in this Limited Warranty, we shall, at our option, repair or replace at no cost to the original purchaser any part covered by this Limited Warranty during the applicable warranty period.

In the event the battery proves defective within ninety (90) days from the date of purchase, we will replace it without charge. If the battery proves defective after (90) days but within one hundred twenty (120) days from the date of purchase, we will replace it for a charge of one half (1/2) of the retail price of the battery in effect at the time of return.

Normal Wear Parts are defined as belts, blades, blade adapters, pneumatic tires, headlights and seat covers. These parts are warranted to be free from defects in material and workmanship as delivered with the product. Any claim for repair or replacement of Normal Wear Parts must be made within thirty (30) days of the date of purchase. No claims involving damage caused from material use, abuse or misuse will be honored.

This **Murray, Inc. Two (2) Year Limited Warranty** is your exclusive remedy; however, this warranty is void or does not apply to any unit that has been tampered with, altered, misused, abused or used for rental or other commercial and/or professional (non-homeowner) uses. Your warranty does not cover minor mechanical adjustments which are not due to any defect in material or workmanship. For assistance in making such adjustments, consult your Instruction Book.

To make a claim under this **Murray, Inc. Two (2) Year Limited Warranty**, return the unit (or if authorized in advance, the defective part) along with your proof of purchase to an Authorized Service Center near you. To locate the nearest Authorized Service Center, call the Central Parts Distributor for your area shown in the list provided with your unit or check the Yellow Page listings in your local telephone directory. If you return the entire unit, we will repair the unit. If we authorize the return of the defective part only, we will either replace or repair the part. In the case of a defect in a transmission or differential (as distinguished from a transaxle), the entire transmission or differential must be returned since they do not include user serviceable parts.

This **Murray, Inc. Two (2) Year Limited Warranty** gives you specific legal rights, and you may also have other rights which vary from state to state. **This Limited Warranty is given in lieu of all other expressed and implied warranties including the implied warranty of merchantability and warranty of fitness for a particular purpose.** If you need additional information on this written warranty or assistance in obtaining service, call or write to the address below. The model number along with the CUSTOMER CARE Center 1-800 number is on the Model Number Nameplate attached to the unit.

MURRAY, INC.

Outdoor Power Equipment
Customer Service Department
P.O. Box 268
Brentwood, Tennessee 37027

OWNER'S INFORMATION

This instruction book is written for a person with some mechanical ability. Like most service books, not all the steps are described. Steps on how to loosen or tighten fasteners are steps anyone can follow with some mechanical ability. Read and follow these instructions before you use the unit.

Know your product: If you understand the unit and how the unit operates, you will get the best performance. As you read this manual, compare the illustrations to the unit. Learn the location and the function of the controls. To help prevent an accident, follow the operating instructions and the safety rules. Keep this manual for future reference.

IMPORTANT: Many units are not assembled and are sold in cartons. It is the responsibility of the owner to make sure the assembly instructions in this manual are exactly followed. Other units are purchased in an assembled condition. On assembled units, it is the responsibility of the owner to make sure the unit is correctly assembled. The owner must carefully check the unit according to the instructions in this manual before it is first used.

RESPONSIBILITY OF THE OWNER

The responsibility of the owner is to follow the instructions below.

1. Carefully read and follow the rules for safe operation.
2. Follow all the assembly and preparation instructions.
3. Inspect the unit.
4. Make sure that the operator of the unit knows how to correctly use all standard and accessory equipment.
5. Operate the unit only with guards, shields, and other safety items in place and working correctly.
6. Correctly adjust the unit.
7. Service the unit only with authorized or approved replacement parts.
8. Complete all maintenance on the unit.

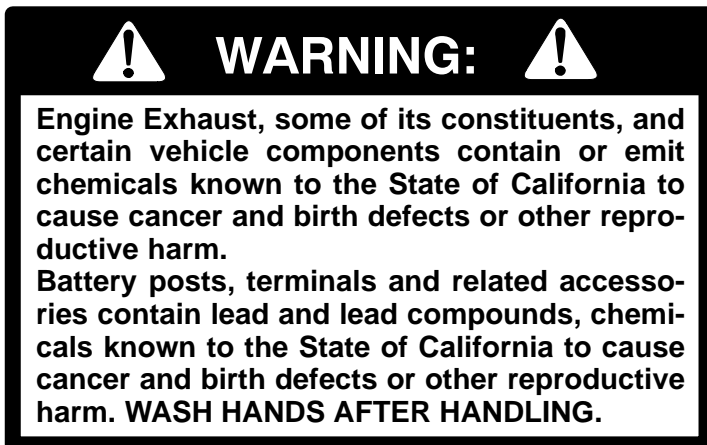

IMPORTANT

Safe Operation Practices for Walk-Behind Mowers.

This cutting machine is capable of amputating hands and feet and throwing objects. Failure to observe the following safety instructions could result in serious injury or death.

I. General Operation

1. Read, understand, and follow all instructions on the machine and in the manual(s). Be thoroughly familiar with the controls and the proper use of the mower before starting.
2. Do not put hands or feet near or under rotating parts. Keep clear of the discharge opening at all times.
3. Only allow responsible individuals, who are familiar with the instructions, to operate the mower.
4. Thoroughly inspect the mower and area where the equipment is to be used. Clear the area of objects such as rocks, toys, wire, bones, sticks etc., which could be picked up and thrown by the blade.
5. Be sure the area is clear of other people before mowing. Stop mower if anyone enters the area.
6. Do not operate the mower when barefoot or wearing open sandals. Always wear substantial foot wear.
7. Do not pull mower backwards unless absolutely necessary. Look down and behind before and while moving backwards.
8. Do not operate the mower without proper guards, plates, grass catcher or other safety protective devices in place.
9. See manufacturer's instructions for proper operation and installation of accessories. Only use accessories approved by the manufacturer.
10. Stop the blade(s) when crossing gravel drives, walks, or roads.
11. Stop the engine (motor) whenever you leave the equipment, before cleaning the mower or unclogging the chute.
12. Shut the engine (motor) off and wait until the blade comes to complete stop before removing grass catcher.
13. Mow only in daylight or good artificial light.
14. Do not operate the mower while under the influence of alcohol, drugs or other medication which can cause drowsiness or affect your ability to operate this machine safely.
15. Never operate mower in wet grass. Always be sure of your footing; keep a firm hold on the handle and walk; never run.
16. Disengage the self-propelled mechanism or drive clutch on mowers so equipped before starting the engine (motor).
17. If the equipment should start to vibrate abnormally, stop the engine (motor) and check immediately for the cause. Vibration is generally a warning of trouble such as a blade that is damaged, a loose blade, or the engine mounting bolts are loose.
18. Always wear safety goggles or safety glasses with side shields when operating mower to protect your eyes from foreign objects which can be thrown from the unit.
19. Plan your mowing pattern to avoid discharge of material toward roads, sidewalks, bystanders and the like.
20. After striking a foreign object, stop the engine. Remove the wire from the spark plug. Inspect the blade and mower for damage. If damaged, repair before starting and operating the mower.
21. Keep any washout ports and other mower housing service openings closed when mowing.

II. Slope Operation

Slopes are a major factor related to slip and fall accidents which can result in severe injury. All slopes require extra caution. If you feel uneasy on a slope, do not mow it.

DO:

Mow across the face of slopes; never up and down. Do not mow excessively steep slopes (maximum 15 degrees) or areas where the ground is very rough. See the "Guide" in the back of this manual to check a slope. Exercise extreme caution when changing direction on slopes.

Remove objects such as rocks, tree limbs, etc.

Watch for holes, ruts, or bumps. Tall grass can hide obstacles.

(Continued Following Page)

IMPORTANT

DO NOT:

Do not mow near drop-offs, ditches, or embankments. The operator could lose footing or balance.

Do not mow excessively steep slopes.

Do not mow on wet grass. Reduced footing could cause slipping.

III. Children

Tragic accidents can occur if the operator is not alert to the presence of children. Children are often attracted to the mower and the mowing activity. *Never* assume that children will remain where you last saw them.

1. Keep children out of the mowing area and under the watchful care of a responsible adult.
2. Be alert and turn mower off if children enter the area.
3. Before and while moving backwards, look behind and down for small children.
4. Never allow children to operate the mower.
5. Use extra care when approaching blind corners, shrubs, trees, or other objects that may obscure vision.

IV. Service

- *1. Use extra care in handling gasoline and other fuels. They are flammable and vapors are explosive.
 - a. Use only an approved container.
 - b. Never remove gas cap or add fuel with the engine running. Allow engine to cool before refueling. Do not smoke.
 - c. Never refuel the machine indoors.
 - d. Never store the machine or fuel container inside where there is an open flame, such as a water heater.
- *2. Never run an engine indoors or inside a closed area.
3. Never make adjustments or repairs to items such as the height adjusters or grass catcher with the engine (motor) running. Discon-

nect the spark plug wire, and keep the wire away from the plug to prevent accidental starting. Always wear eye protection when you make adjustments or repairs.

4. Keep all nuts and bolts, especially blade attachment bolts, tight and keep equipment in good condition.
5. Never tamper with safety devices. Check their proper operation regularly.
6. To reduce fire hazard, keep mower free of grass, leaves, or other debris build-up. Clean up oil or fuel spillage. Allow mower to cool before storing.
7. Stop and inspect the equipment if you strike an object. Repair, if necessary, before re-starting.
8. Never attempt to make wheel height adjustments while the engine (motor) is running.
9. Always disconnect electric mowers (live operated) before cleaning, repairing, or adjusting.
10. Grass catcher components are subject to wear, damage, and deterioration, which could expose moving parts or allow objects to be thrown. Frequently check components and replace with manufacturer's recommended parts, when necessary. For storage, always make sure grass catcher is empty.
11. Mower blades are sharp and can cut. Wrap the blade(s) or wear gloves, and use extra caution when servicing them.
12. Do not change the engine governor setting or over-speed the engine.
13. Frequently check the blade for wear or damages such as cracks and nicks. A blade that is bent or damaged must be immediately replaced with a factory replacement blade. For safety and good cutting performance, replace the blade every two years. Frequently check the blade bolt and the engine mounting bolts. Replace damaged bolts and tighten loose bolts.
14. Use only original equipment or authorized replacement parts.

* Asterisked items do not apply to electric mowers.

SAFE MOWING GUIDE

Every person who uses power equipment must learn the difference between proper and improper use, safe and unsafe mowing practices. **Read the next few pages carefully. They can help you learn.** Too often the mower user is inexperienced, not properly instructed, or has not read the Instruction Book and instructions on the unit before using it for the first time. This can result in unsafe use endangering the operator, bystanders, and the equipment. Another result can be a poor appearance of the area mowed.

Read this Instruction Book. Read the instructions on the unit. Operate the mower according to the Safe Mowing Guide and other safety rules and recommendations in this Instruction Book and on the unit. Make sure anyone who uses the unit has read the instructions and has been told how to operate the mower safely.

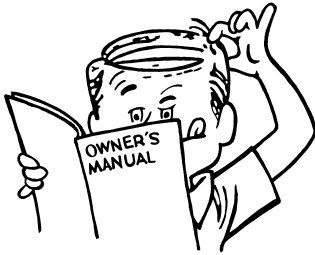

Your mower is designed to provide good service and durability in normal residential cutting. If the mower is not properly serviced and maintained or used on unsuitable terrain or in conditions not suitable for mowing, product performance and safety will be reduced.

Proper attire is an important part of safe mowing. Safety glasses protect the eyes from thrown objects. Safety shoes with steel toes can protect a foot from being cut by the blade. Shirts and pants that cover the arms and legs can stop or deflect a thrown object.

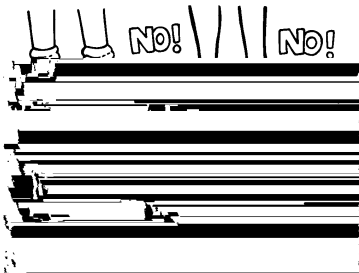

Practice using the mower before you actually begin cutting grass. Select a large open level area. Learn the location and function of the controls and how they work. It is important that the blade can be stopped quickly in an emer-

gency. Learn how to cut and how to keep control of the mower at all times.

Many mowers are started manually. When using a pull start or rope start, place your feet firmly and away from the blade. Hold the rope handle securely, but never wrap the rope around your arm or fingers for a "better grip".

The mower is designed for use by one person. Always mow alone. Never carry passengers. Carrying a passenger is dangerous for the passenger and the operator. A mower is not for amusement or for carrying objects.



Is the area you are planning to mow wet? Never cut a wet lawn. Cutting wet grass can cause an accident. It can affect mower performance and also cause problems with future lawn growth and appearance. Wet grass is slippery and might cause the operator to fall or the mower to slip. Someone could be hurt by touching the blade. Wet grass tends to clog the mower, causing poor discharge. Wet clippings bunch up on the lawn retarding the growth of grass. A wet mower can cause parts to rust and reduce the useful life of the unit.



When you look over the lawn, refresh your memory about hard, immovable obstacles such as pipes, stumps, and rocks and avoid them. They can cause damage to the mower or an accident injuring the operator or a bystander. Take a litter bag along and walk over the area to be cut. Pick up any stones, toys, wire, bones, or other loose objects. These items can damage the mower or they can become dangerous flying objects if the mower blade hits them. The blade of a power mower travels very fast. It can throw rocks and other objects with force over long distances. Objects thrown by mowers can break windows, cause

SAFE MOWING GUIDE

bruises, or even put out an eye. Often the person hurt by a thrown object is a bystander such as a child, another family member or a neighbor. Keep people and pets completely away from the mowing area. Direct the mower's discharge away from areas where people can be. Planning your mowing pattern has a double benefit. It can reduce chances of an injury and make the clean up after mowing easier.

Are there ditches, walls, or major inclines in the area to be cut? Plan the mowing pattern to avoid such danger areas. Inclines and rough terrain must be mowed carefully and some areas must not be cut with a mower at all. With walk behind equipment, mow across the incline so that if you or the mower slip, you won't run into each other.



Never mow slopes greater than 15 degrees. See the "Guide" in the back of this Instruction Book to check any slopes.

Ready to start cutting? Not yet. Be sure the mower has been fully assembled according to directions in the Instruction Book. Even if assembly was done by a lawn and garden shop or the store where the unit was purchased, it must be checked. Are all nuts, bolts and screws tight? Does the engine have oil? These items must be checked periodically throughout the life of the mower.

Your mower has a gasoline engine. Gas is dangerous. Store fuel only in a approved gas container. Do not store large amounts of gas. Put out all cigarettes, pipes and cigars before working with gasoline. Store fuel and the mower itself in a well ventilated area away from any possible source of ignition such a pilot light on a furnace. If the mower is to be stored for an extended time, remove the gas from the tank. This minimizes the chance of a fire and keeps the tank clear of deposits and old gasoline, thus improving mower performance. Move the mower outside before adding gasoline. Use a funnel and wipe up any spilled fuel before starting. Remember, gasoline expands when heated so leave some expansion room. Also, most mower gas caps are vented to allow for expansion. Always use the proper cap. People are needlessly burned by fires, hurt in explosions, mowers and other property are damaged because of failure to follow basic safety rules related to gasoline and fueling.

Never add gasoline to an engine that is running or that is hot from recent use, this can cause an accident. Remove dry grass and other debris from the mower. Keeping the mower clean will

improve the performance, help the engine stay cooler, extend the life of moving parts, and minimize the danger of fire. People get burned working with and around their mowers for other reasons than fire and explosions. It takes only a few seconds of operation for the engine and the muffler to become hot. Do not touch these parts when the mower is running. Stop the engine and let it cool down before servicing the mower. Remember, exhaust fumes can be dangerous. Never operate the engine indoors or in an enclosed area.

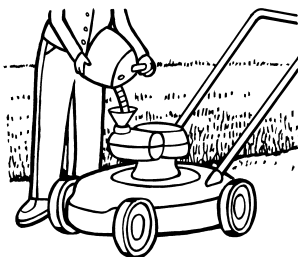

Getting a new mower can be a big event for a family. Let family members satisfy their curiosity about the mower and at the same time, tell them about its dangers. Remember, a mower is not a toy and is not for use by children or anyone lacking in age, strength or experience.

As with any power equipment, a mower can be dangerous if not assembled, misused, or not properly maintained. The most important rule is to always use good judgement and common sense.

Your mower will cut thick grass and heavy plant stems with ease. Fingers and toes are no more resistant to the mower's blade. Many people are injured because they "forgot" and reached into the discharge chute. Always treat your lawn mower as if the blade is rotating. Never perform any service or try to make any adjustment, except carburetor, while the engine is running.

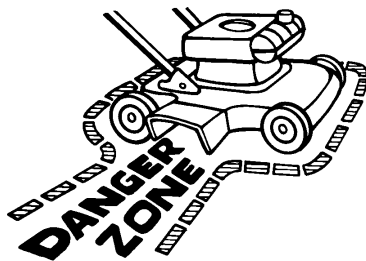

Use only accessories suited for your mower. Use of improper accessories can reduce the safety designed into both the mower and the accessory, it can even damage the unit. Read and follow the instructions which come with the accessory and the mower.

SAFE MOWING GUIDE

Use only original equipment or approved substitutions as service parts. If you need professional service, select a shop that is an Authorized Service Center for your brand of mower. If you plan to service the unit yourself, follow directions in the Instruction Book.



As you mow, remember children and pets are sometimes attracted to the activity. Be especially careful when trimming around shrubbery or when backing up. If at all possible, don't mow when moving backwards. It is dangerous because vision is restricted. Also, blades are designed to cut while the unit is moving forward so cutting performance is reduced when mowing in reverse.

Never leave the mower running and unattended. Shut off the engine. Put the mower in a position so that it can not roll. If the unit is self-propelled, make sure the drive control is disengaged.

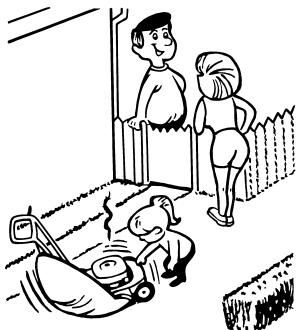

When mowing, be aware of your condition and the weather conditions. After mowing a long time, you will be tired. This is the time when reactions slow down, your attention wanders; the time when you are wide open for an accident. Take a short break. If temperatures are high, take precautions to avoid becoming dehydrated. If you are angry, tired, or unable to give your full attention to mowing, if you have been consuming alcohol, medicines, or drugs, do not use your mower or any type of power equipment.

If weather conditions become worse while you are cutting, stop and finish later. Cutting grass

in the rain is no fun and it is dangerous. Always seek shelter in an electrical storm. In extremely dry mowing conditions, your safety glasses can serve a dual purpose by protecting your eyes from dust and thrown objects, also a dust or pollen mask can be helpful.

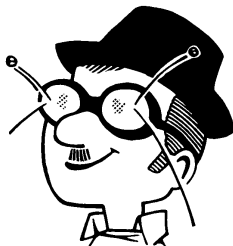

Your mower is equipped with a number of safety features which are important to the safety of the operator and bystanders and must never be altered or removed. If a safety feature becomes inoperable, lost, or damaged, it must be repaired or replaced before the mower is used.

Engine speed is a key to safe mowing and a nice looking lawn. The maximum speed of the engine on your mower has been set at the factory. Do not change the engine governor in any way.

Select the maximum engine and ground speed that is right for the terrain and the height of grass. You get the best cutting and bagging performance when using a grass catcher by operating the engine at maximum speed. Never walk fast or run just to get the job done sooner. On inclines, reduce ground speed and exercise extreme care.

It is best to mow only during daylight hours; however, if you must mow in the late afternoon or evening, make sure there is good artificial light.

Your mower will require maintenance including service and adjustments before and after use as with any machine. The frequency of the maintenance is generally based on hours of use, however, the frequency can vary because of mowing conditions. Check the Instruction Book for more detailed instructions. Proper maintenance protects your investment in the mower and helps insure that it will function safely and reliably.

Never attempt any service (with the possible exception of carburetor adjustment) with the engine running. After turning the engine off, always disconnect the spark plug wire to prevent accidental restarting while the unit is being serviced.

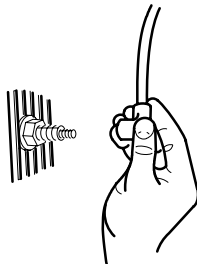

SAFE MOWING GUIDE

While mowing, if you hit a foreign object, stop the engine. Remove the spark plug wire. Carefully and thoroughly inspect the mower for damage. Make necessary repairs before re-starting. If the unit starts to vibrate abnormally, stop the engine immediately and check for the cause. Vibration is generally a warning of trouble. Keep all nuts, bolts, and screws tight.

The blade is the most dangerous part of the mower and also the most important part in obtaining a nice lawn appearance. Check the blade and the blade mounting hardware frequently. Keep it tight. If the blade hits a solid object, check it thoroughly for deformation or cracks and replace if damaged. For safety, replace the blade every two years. A sharp blade reduces the work load on the engine and cuts grass more cleanly, for a better looking cut with less work. The blade is always close to the outside of the mower housing. For best trimming on side discharge mowers, cut with the left side of the housing toward the area that needs trimming.

A useful accessory for your mower is a grass catcher. There are grass catchers available for most models. For best performance and safety, be sure the grass catcher is approved for use with your mower. Assemble as directed and follow operating and safety instructions with the catcher and in the Instruction Book.

Before mounting, checking or emptying the grass catcher, always turn the engine off. Remember to check the grass catcher before each use for cracks, wear, or deterioration. Replace any part that is damaged with the manufacturer's recommended replacement part before using the grass catcher again.



Proper cutting technique is important if you want your lawn to look good. Avoid the temptation to cut grass too short. Cutting grass too short can kill the plant, cause grass to turn yellow, or make the lawn look brown and thatchy. Use the lower cutting heights in cool months when the grass is lush. Use the higher cutting heights in extremely dry periods. Cutting with a dull blade or low engine speed bruises, shreds, and can uproot some grass making the lawn look dull and brown a few days after cutting. Always put the throttle control in FAST

position when mowing and bagging. When bagging, slower ground speed will provide the best results.

Change the mowing pattern slightly each time you cut. If you always cut the same way, the grass will develop a "set" and clippings will accumulate more heavily in some areas more than in others causing grass to get thinner in those areas. Do not service your mower over the grass. Spilled oil and gas can kill the grass. In tall grass or very heavy grass, do not try to cut it all at once. Raise the height of cut on the first cutting and lower it for the next cutting the same day or within a few days. Another way is to cut only part of the width of the mower and adjust your ground speed (not the engine) to move more slowly so the mower can clear itself as it moves forward.

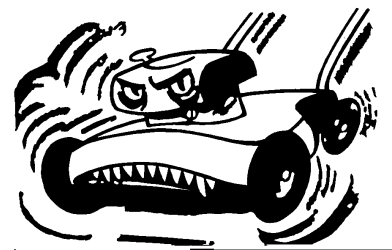

When cutting with a walk behind mower, always push the unit. Do not pull it. Pushing the unit keeps the operator behind the mower in the "operator's zone" for better control. Pushing the unit also gives you a chance to see exactly where and what you are mowing. There will be times while you are mowing that you will have to pull the mower backwards (such as when the front of the mower has come up against a wall or fence). If you must back up, make sure your feet are in the clear. Stand well back from the mower, plant your feet firmly with each step and back up being careful to look behind you. Resume normal mowing as soon as possible.

If your unit is self-propelled, remember that the drive mechanism is not designed to do all the work, but the unit can move without your help. Always keep your hands on the handle near the controls when the engine is running. Remember too that the self-propelled mechanism can be dangerous. Keep hands and feet away from belts and chains. Always turn off the engine before attempting to remove anything that becomes entangled in the self-propelled system.

Remember, your mower is a useful tool, but it can be dangerous. Follow the instructions in this Instruction Book. Use the mower properly and carefully and it will give you many hours of trouble free, accident free operations.

STEPS TO FOLLOW

BEFORE MOWING

- Be sure to dress correctly. Wear hard shoes, not sandals or tennis shoes.
- Examine the blade. A blade that is bent, cracked, or damaged must be replaced with a factory replacement blade.
- Fill the fuel tank outside. Clean off spilled fuel.
- Read and follow the Owner's Manual, the instructions with the engine, and the instructions with any attachments. Owner's Manual instructions are for your safety and the safety of others.
- Exhaust fumes are dangerous. Start the engine outside.
- Make sure all safety devices are in place and working correctly.
- Operation of the mower is only for a person that has experience.
- Wet grass can be dangerous. Let the grass dry.
- Instruct children and others to keep away from the work area.
- Never cut the grass without good light.
- Pick up loose objects. Remove them from the mowing area.

WHILE MOWING

- Watch for fixed objects and avoid them. They can damage the mower or cause injury.
- A hot engine and muffler will cause a burn. Do not touch.
- Inclines and slopes must be carefully mowed. See the "Guide" in the back of this book to check a slope.
- Lack of daylight or good artificial light is cause to stop mowing.
- Examine the mower, the blade, and other parts for damage after hitting a foreign object or if the unit vibrates excessively.
- Do not make adjustments or repairs without stopping the engine (except for carburetor). Disconnect the spark plug wire.
- On or near roads, watch out for traffic. Direct discharge away from roads.
- When mowing, avoid areas where traction is unsure. Before and while moving backwards, look behind and down for small children.
- In heavy grass, raise the cutting height. Cut slower. Stop the engine to remove clogged grass from the mower.
- Never remove any safety related parts.
- Do not pour gasoline into a engine that is hot or running.

AFTER MOWING

- Always let the mower cool before storing in an enclosed area.
- Foreign material on the mower is dangerous. Clean off grass, leaves, grease and oil before storing.
- Tighten all loose nuts, bolts and screws before you use the unit.
- Empty and clean any grass catcher or other accessory.
- Remove the key or disconnect the spark plug wire to prevent unauthorized use.
- Make sure the mower is not kept near a source of ignition. Gas fumes can cause an explosion.
- Only original parts or factory approved substitutes can be used to service the mower.
- When storing the mower for an extended period, remove the fuel from the fuel tank.
- Instruct children to leave the mower alone. It is not a toy.
- Never keep gasoline near a source of ignition. Always use an approved container. Keep gasoline away from children.
- Lubricate according to the Instruction Book. See "Lubrication".

IMPORTANT--Read the Instruction Book. Keep this book for future use and reference.



WARNING: Look for this symbol to point out important safety precautions. It means: "Attention! Become Alert! Your Safety Is Involved."

PREPARATION

Read and follow the assembly and adjustment instructions for your mower. All fasteners are in the parts bag. Do not discard any parts or material until the unit is assembled.



WARNING: Before doing any assembly or maintenance to the mower, remove the wire from the spark plug.

NOTE: Torque is measured in foot pounds (metric N.m). This measurement describes how tight a nut or bolt must be. The torque is measured with a torque wrench.

TOOLS REQUIRED

- 1 Pliers
- 2 Adjustable open end wrenches
- 1 Blade type screwdriver
- 1 Phillips screwdriver

PARTS BAG - CONTENTS

The fasteners and other loose parts are shown below. The fasteners are shown at full size.

NOTE: Your model will not use every fastener shown on this page.

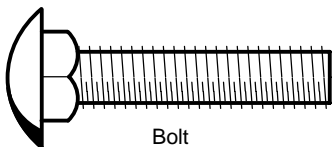

Bolt
2x81

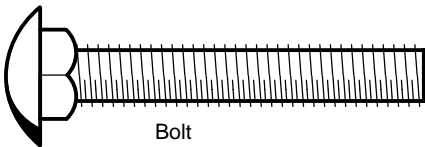

Bolt
2x77



Locknut
15x116

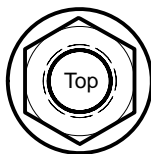

Top

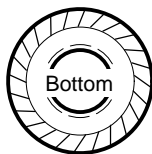

Bottom

Flange Nut
15x68

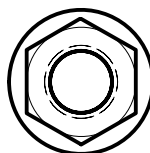

Flange Nut
15x84

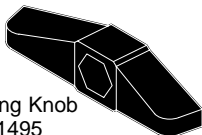

Locking Knob
71495

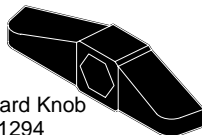

Standard Knob
71294

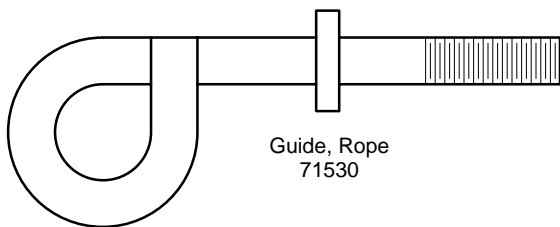

Guide, Rope
71530

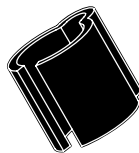

Fastener, Cable
1101353

PREPARATION

Handle

1. Remove the mower from the carton.
2. Put the **lower handle** in the operating position. Make sure the **lower handle** is between the **locking tabs** (Figure 1).
3. Attach the **lower handle** to the **handle brackets** with the fasteners as shown.
4. Attach the upper handle to the lower handle with the fasteners as shown (Figure 2).

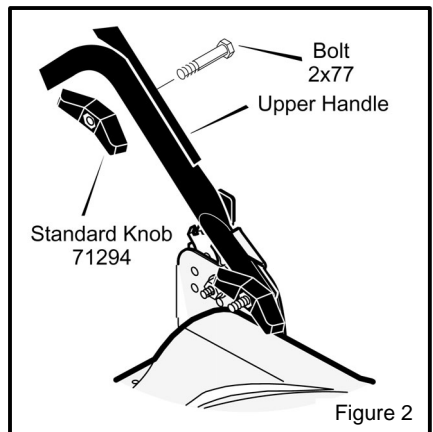
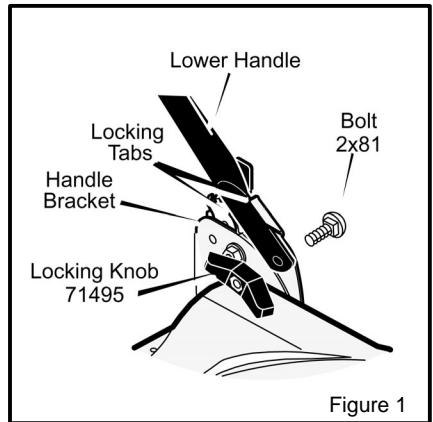

PREPARATION

HOW TO ASSEMBLE THE CONTROLS TO THE HANDLE

Two types of handles are shown in Figure 3. The engine on your model will determine which type of handle is on your model. **Type A** is for models with Briggs & Stratton engines. **Type B** is for models with Tecumseh engines.

Note: On models with Briggs & Stratton engines, make sure the stop lever bracket is on the *left side* of the handle. On models

with Tecumseh engine, make sure the stop lever bracket is on the

PREPARATION

HOW TO ASSEMBLE THE WHEELS AND HEIGHT ADJUSTERS

1. First, determine which of the height adjusters to attach to the **front** of the mower housing. The **front height adjusters** have **index plates** attached to the height adjusters (Figure 7). The **rear height adjusters** do not have **index plates**.
2. Attach the **front height adjusters** to the **mower housing** with the **locknuts** as shown. Make sure to mount each **front height adjuster** with the **axle** toward the front.
3. Attached the **rear height adjusters** to the **mower housing** with the **locknuts** as shown. Make sure to mount each **rear height adjuster** with the **axle** toward the rear.
4. Mount the **wheels** onto the **height adjusters** with the fasteners as shown.

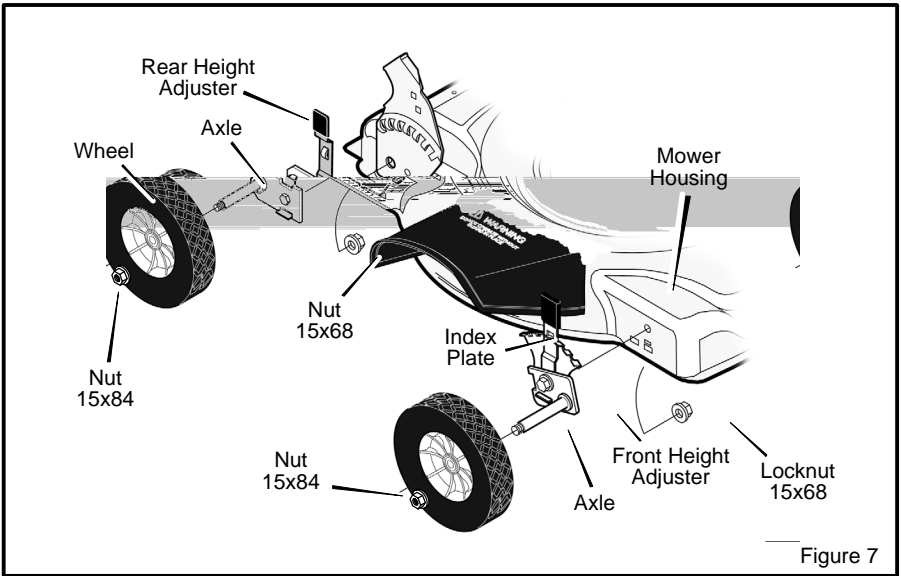

PREPARATION

HOW TO PREPARE THE ENGINE

ENGINE DOES NOT CONTAIN OIL OR GASOLINE

See the engine manufacturer's instructions for the type of gasoline and oil to use. Before you use the unit, read the information on safety, operation, maintenance, and storage.



WARNING: Follow the engine manufacturer's instructions for the type of gasoline and oil to use. Always use a safety gasoline container. Do not smoke when adding gasoline to the engine. When inside an enclosure, do not fill with gasoline. Before you add gasoline, stop the engine. Let the engine cool for several minutes.

IMPORTANT: This unit is equipped with an internal combustion engine and must not be used on or near any unimproved forest-covered, brush-covered or grass-covered land unless the engine's exhaust system is equipped with a spark arrester meeting applicable local or state laws (if any). If a spark arrester is used, it must be maintained in effective working order by the operator.

In the State of California the above is required by law (Section 4442 of the California Public Resources Code). Other states may have similar laws. Federal laws apply on federal lands. See an Authorized Service Center for a spark arrester for the muffler.

NOTE: Actual sustained horsepower will likely be lower due to operating limitations and environmental factors.

FINAL ASSEMBLY

Before you use the mower, check the assembly of the wheels, the handle, and the controls. Make sure all the fasteners are tight. Make sure the throttle control and the engine stop lever work correctly.

OPERATION

ENGINE STOP LEVER

Release the **engine stop lever** and the engine and the blade will automatically stop. To run the engine, hold the **engine stop lever** in the **Operating position** (Figure 8).

Before you start the engine, operate the **engine stop lever** several times. Make sure the cable moves easily.

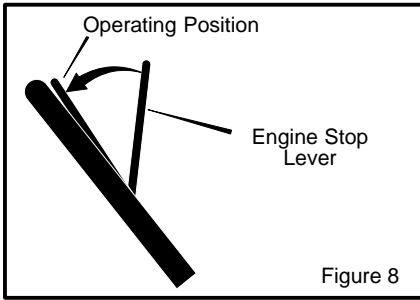

HOW TO STOP THE ENGINE

To stop the engine, release the **engine stop lever**. Disconnect the wire from the spark plug to prevent the engine from starting.

If the engine will not stop, hold a screwdriver against the spark plug and against the engine cooling fins. The spark will go to ground and the engine will stop. Before you start the engine, check the engine stop cable. Make sure the engine stop cable is assembled correctly. Before you operate the unit, replace a bent or damaged engine stop cable.

HOW TO START ENGINE



WARNING: The blade will rotate when the engine runs.

IMPORTANT: Before you start the engine, operate the engine stop lever several times. Make sure the engine stop cable moves freely.

NOTE: The engine design does not include a throttle control or an engine speed adjustment. The engine is set at the best speed for cutting grass, bagging grass, and for extended engine life.

1. Check the oil.
2. Fill the fuel tank with regular unleaded gasoline. Make sure the gasoline is clean. Leaded gasoline will increase deposits and shorten the life of the valves.

NOTE: Do not use gasohol or methanol. Do not use premium unleaded gasoline.

F-030401L

WARNING: Always use a safety gasoline container. Do not smoke when adding gasoline to the fuel tank. When inside an enclosure, do not add gasoline. Before you add gasoline, stop the engine and let the engine cool for several minutes.



3. Make sure the spark plug wire is connected to the spark plug.
4. The **primer button** is on the side of the engine (Figure 9). Push the **primer button**. Every time you push the **primer button**, wait two seconds. For the number of times required to push the **primer button**, see the engine manufacturer's instructions.

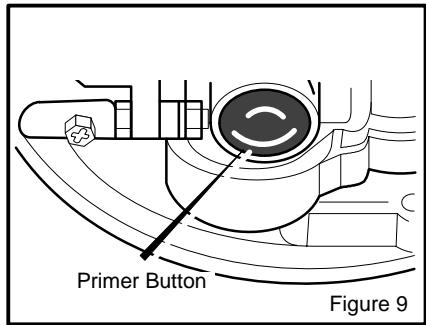

NOTE: Do not use the primer button to start a warm engine.

5. Stand behind the mower (Figure 10). Use one hand to hold the **engine stop lever** in the operating position as shown. Use the other hand to hold the **recoil-start grip**.
6. Rapidly pull the **recoil-start grip**. Slowly return the **recoil-start grip**.
7. If the engine does not start in 5 or 6 tries, See the "Problem and Repair" Instructions.

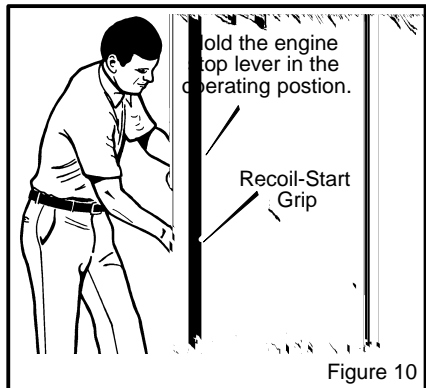

MAINTENANCE

ENGINE MAINTENANCE

Use the following maintenance section to keep your unit in good operating condition. All the maintenance information for the engine is in the "Engine Instruction Book". Before you start the engine, read this book.



WARNING: Before you make an inspection, adjustment (except carburetor), or repair, stop the engine and disconnect the wire from the spark plug.

ENGINE TIPPING

When you service the engine, inspect the blade, or clean the underside of the mower housing; make sure to always tip the engine with the spark plug up (see Figure 11). Transporting or tipping the engine with the spark plug down will cause:

- Hard starting.
- Engine smoking.
- Spark plug fouling.
- Oil or gas saturation of the air filter.

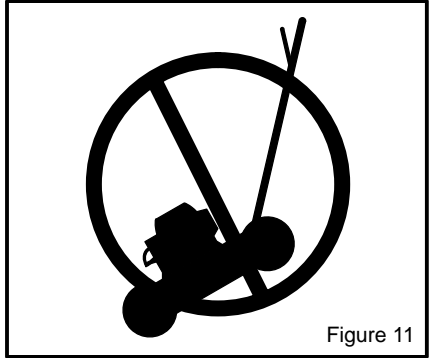

Figure 11

HOW TO CLEAN THE MOWER HOUSING



WARNING: The blade will rotate when the engine runs. Before you clean the mower housing, stop the engine and disconnect the wire from the spark plug.

Grass and other debris can keep the mower from working correctly. After you mow, clean the mower housing as follows.

1. Stop the engine.
2. Disconnect the wire from the spark plug.
3. Clean the top and the bottom of the mower housing.

LUBRICATION

1. For maximum performance, lubricate the wheels and all pivot points with engine oil every 25 hours.
2. To lubricate the engine, refer to the "Engine Instruction Book".

NOTE: Do not lubricate the engine stop cable. Lubricants will damage the cable and prevent the cable from moving freely. Replace the cable if bent or damaged.

F-030401L

HOW TO ADJUST THE HEIGHT OF CUT



WARNING: The blade will rotate when the engine runs. Before you change the height of cut, stop the engine and disconnect the wire from the spark plug.

To change the height of cut, move the position of the **adjuster arm** at each wheel (Figure 12). Make sure each **adjuster arm** is in the same position so that the mower will cut level.

1. Disengage the **adjuster arm**.
2. Move the **adjuster arm** to another position.

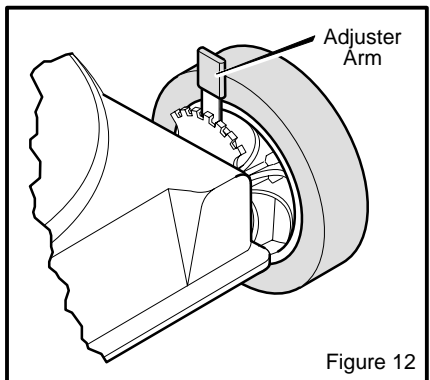
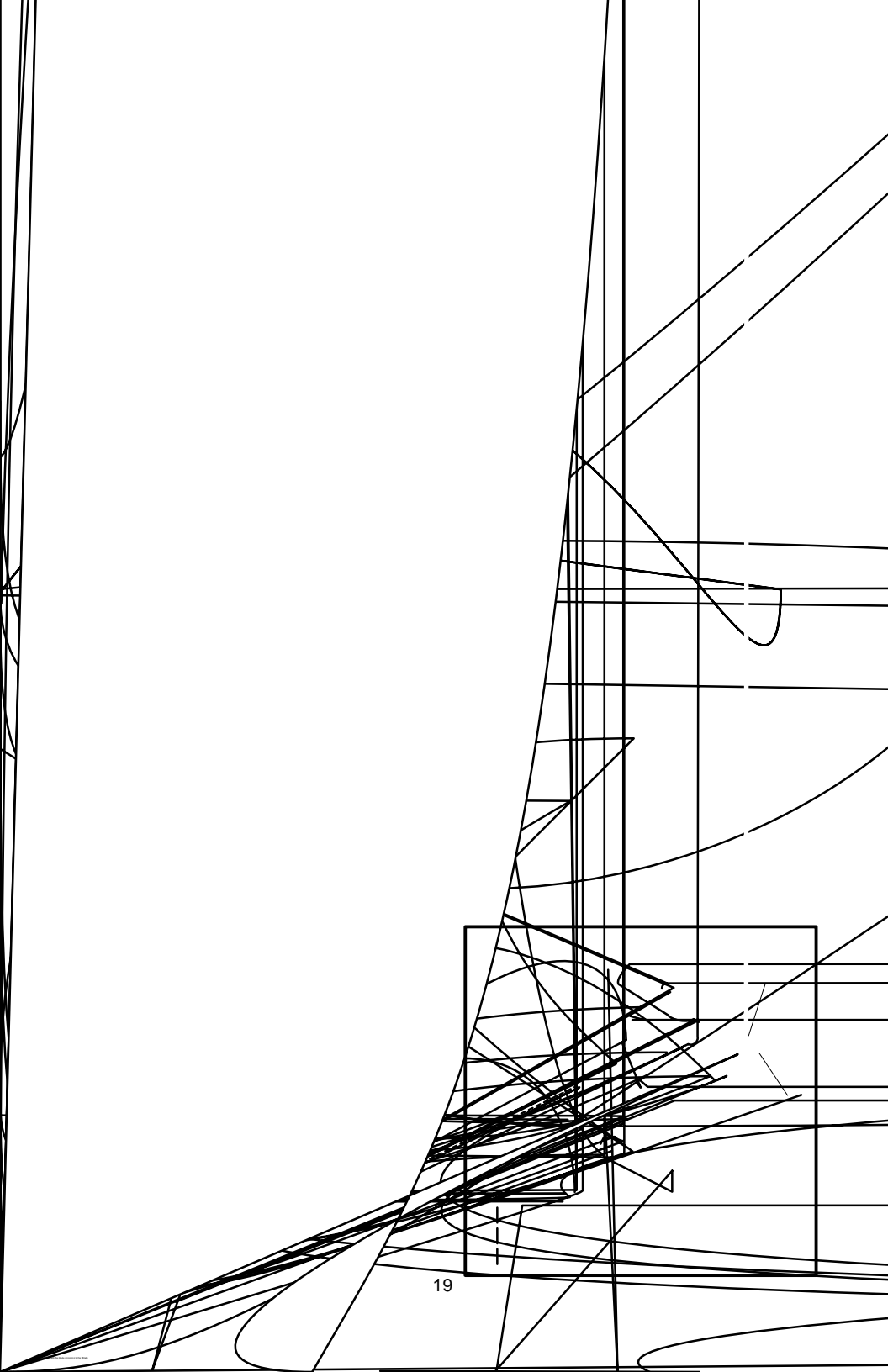

Figure 12



MAINTENANCE

5. Make sure the **blade** is balanced. Use a **screwdriver** and hold the blade parallel to the ground as shown. A blade that is balanced will stay parallel to the ground. If the blade is not balanced, the heavy end will rotate toward the ground. Sharpen the heavy end until the blade is balanced.
6. A new blade will cut better than a badly worn blade. Every two years replace the old blade with a factory replacement blade.

CHECK THE LEVEL OF CUT

Test the unit in a small area. If the height of cut is not level or if the cut grass is not discharged, the cause can be: (1) the blade is bent or damaged, (2) the blade is not sharp, (3) a worn blade, (4) or a broken **blade adapter**. Before you use the unit, correct the problem.

FOLDING HANDLE STORAGE

CAUTION: Be careful when you fold or raise the handle. Do not damage the cables. A cable that is bent will not work correctly. Before you use the unit, replace a bent or damaged cable.

How To Fold The Handle

1. Loosen the knobs that hold the upper part of the handle to the lower part of the handle. As you fold the handle, make sure the cables are not around the loose fasteners and do not become damaged. Rotate the upper part of the handle toward the back of the unit (Figure 15) .
2. Loosen the knobs on the lower handle (Figure 16). Push in on the ends of the **lower handle**. Move the ends of the **lower handle** past the **locking tabs**.
3. Rotate the handle forward over the engine. Make sure the cables are not damaged.

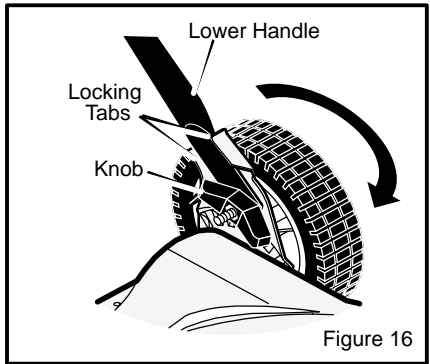
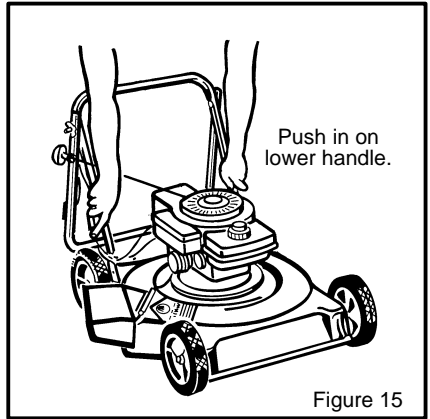

How To Raise The Handle

1. Pull the handle back until the ends of the **lower handle** lock into position.
2. Lift the upper part of the handle into the operator's position. Tighten the fasteners that hold the handle.

HOW TO PREPARE THE MOWER FOR STORAGE



WARNING: Do not remove gasoline while inside a building, near a fire, or while you smoke. Gasoline fumes can cause an explosion or a fire.

1. Drain the fuel tank.
2. Let the engine run until it is out of gasoline.
3. Drain the oil from the warm engine. Fill the engine crankcase with new oil.
4. Remove the spark plug from the cylinder. Pour one ounce of oil into the cylinder. Slowly pull the recoil-start grip so that the oil will protect the cylinder. Install a new spark plug in the cylinder.
5. Clean the dirt and debris from the cylinder cooling fins and the engine housing.
6. Clean the bottom of the mower housing.
7. Completely clean the mower to protect the paint.
8. Put the unit in a building that has good ventilation.

TROUBLE SHOOTING CHART

The Engine will not start.

1. Move the throttle control lever to the FAST or START position.
2. Make sure the fuel tank is filled with clean gasoline. Do not use old gasoline.
3. On a cold engine, push the primer button (optional on some models) five times.
4. Make sure the wire for the spark plug is connected to the spark plug.
5. Adjust the Carburetor. See the "Engine Instruction Book".
6. There is too much gasoline in the engine cylinder. Remove and dry the spark plug. Put the throttle control in the SLOW position. Pull the recoil-start grip several times. Install the spark plug. Connect the wire to the spark plug. Start the engine.
7. The engine is difficult to start in heavy or high grass. Move the mower to a clean dry surface.
8. Make sure the engine stop lever is in the operating position.
9. Make sure the fuel valve is in the ON position. See the "Engine Instruction Book".
10. On electric start models, make sure the wiring harness is connected. Charge the battery.

The Engine will not stop.

1. Release the engine stop lever.
2. Check the engine stop cable. Replace the cable if bent or damaged.

The Engine performance is bad.

1. Check the height of cut settings. Raise the height of cut if the grass is high.
2. Check the bottom of the blade housing. Clean the blade housing of grass and other debris.
3. Check the wire to the spark plug. Make sure the wire is connected.
4. Clean the engine cooling fins of grass and other debris.
5. Check the carburetor adjustments. See the "Engine Instruction Book".
6. Check the spark plug gap. Set the spark plug gap at 0.030".
7. Check the amount of oil in the engine. Fill with oil if necessary.
8. Check the engine air cleaner. See the "Engine Instruction Book".
9. The gasoline is bad. Drain and clean the fuel tank. Fill the fuel tank with clean gasoline.
10. Check the throttle control. Make sure the lever is not in the CHOKE position.

Excessive Vibration.

1. Remove the blade. Check the blade and balance if necessary. See the blade maintenance instructions.
2. Check for a bent or broken blade. A DAMAGED BLADE IS DANGEROUS AND MUST BE REPLACED.
3. Check the blade adapter. REPLACE A BROKEN BLADE ADAPTER.
4. If the vibration continues, take the mower to an Authorized Service Center.

The grass will not discharge correctly.

1. Clean the bottom of the mower housing.
2. Check for a badly worn blade. Remove and sharpen the blade. For safety, replace the blade every two years with a factory replacement blade.
3. Move the throttle control lever to the FAST position. Check the speed of the engine according to the "Engine Instruction Book".

The grass is not cut even.

1. Check the height adjustment at each wheel. The height adjustment must be the same for each wheel.
2. Make sure the blade is sharp.
3. Check for a bent or broken blade. A DAMAGED BLADE IS DANGEROUS AND MUST BE REPLACED.
4. Check for a broken blade adapter. REPLACE A BROKEN BLADE ADAPTER.

HANDLE - BRIGGS & STRATTON MODELS

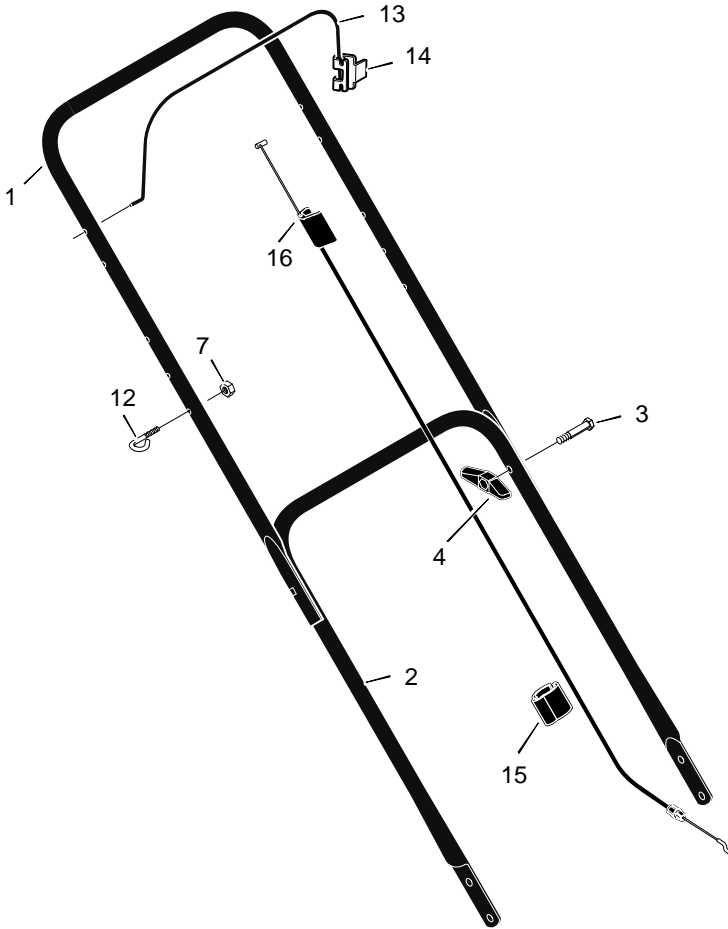

KEY NO.	DESCRIPTION	PART NO.	KEY NO.	DESCRIPTION	PART NO.
1	Handle, Upper (Black)	1101556E701	12	Guide, Rope	71530
	Handle, Upper (Gray)	1101556E724	13	Engine Stop Lever	43653E700
2	Handle, Lower (Black)	71137E701	14	Bracket, Stop Lever	1101454
	Handle, Lower (Gray)	71137E724	15	Fastener, Cable	1101353
3	Bolt	2x77	16	Engine Stop Cable *	672840
4	Knob, Plastic	71294		Engine Stop Cable #	1101181
7	Locknut	15x116			

* Used on Briggs & Stratton Classic, Sprint, Quattro, Q-Style and QS-Style engines.

Used on Briggs & Stratton Quantum engines.

HANDLE - TECUMSEH ENGINE MODELS

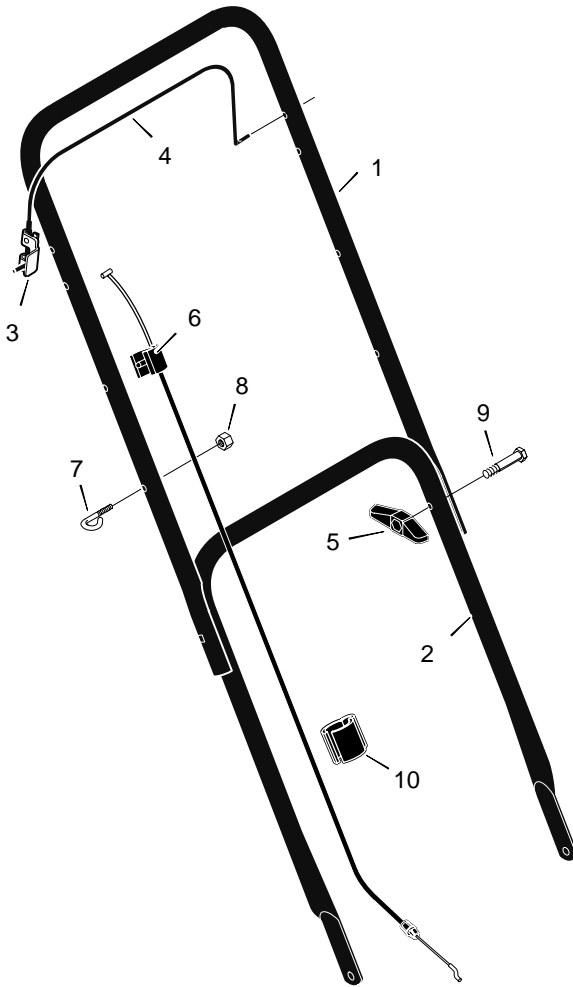

KEY NO.	DESCRIPTION	PART NO.	KEY NO.	DESCRIPTION	PART NO.
1	Handle, Upper (Black) Handle, Upper (Gray)	1101556E701 1101556E724	6	Engine Stop Cable	672835
2	Handle, Lower (Black) Handle, Lower (Gray)	71137E701 71137E724	7	Guide, Rope	71530
3	Bracket, Stop Lever	1101454	8	Locknut	15x116
4	Lever, Stop	43653E700	9	Bolt	2x77
5	Knob, Plastic	71294	10	Fastener, Cable	1101353

MODELS WITH STANDARD WHEELS

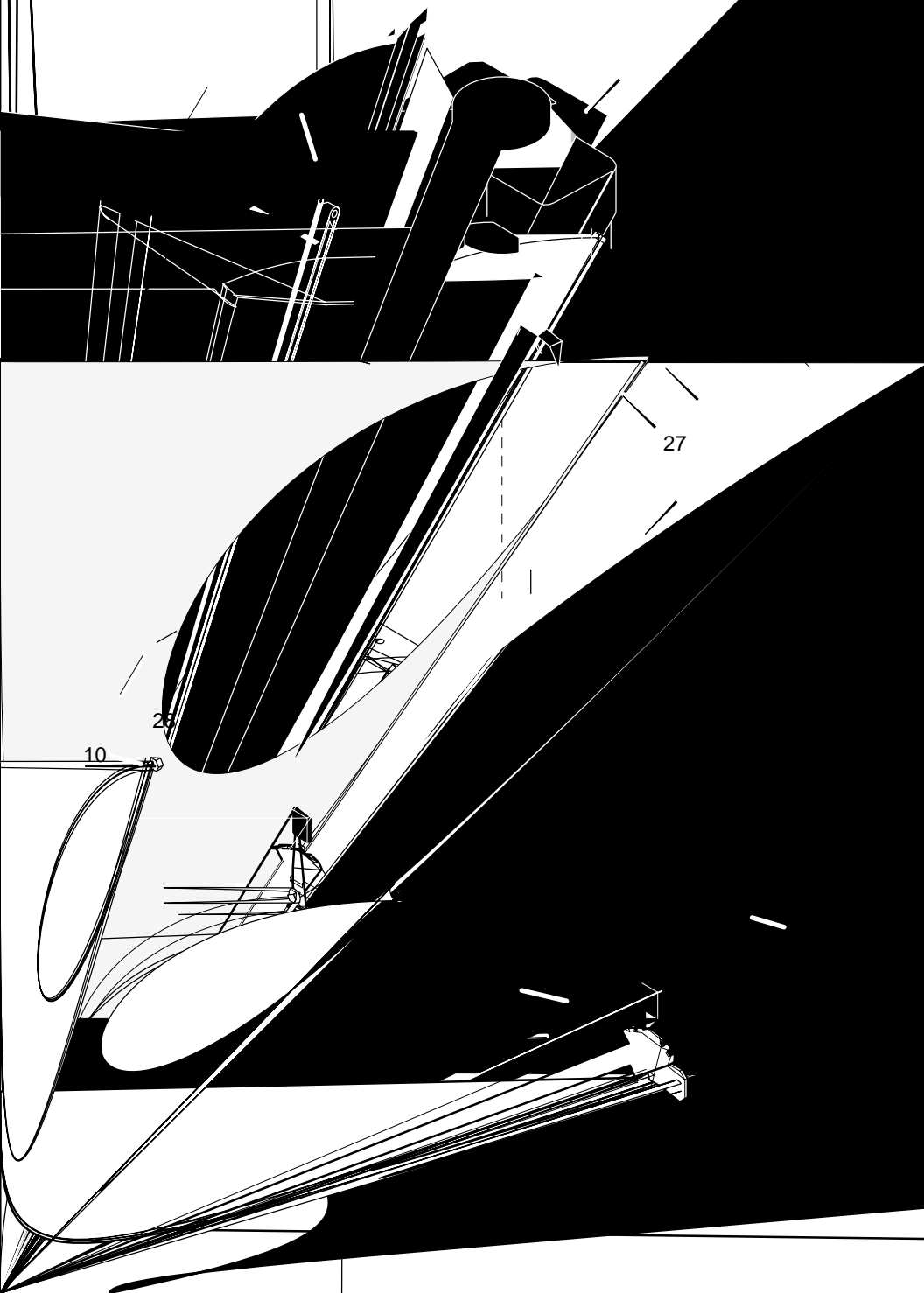

MODELS WITH STANDARD WHEELS

KEY NO.	DESCRIPTION	PART NO.
1	Engine ‡	-----
2	Housing	776022
3	Height Adjuster, Left Rear (8" Wheels)	672641
	Height Adjuster, Left Rear (7" Wheels)	672637
4	Knob	71495
5	Wheel and Tire #	-----
6	Locknut, Flange	15x84
7	Bolt, Carriage	2x81
9	Bolt, Engine	25x6
10	Nut	15x68
11	Height Adjuster, Left Front (8" Wheels)	672601
	Height Adjuster, Left Front (7" Wheels)	672635
12	Washer, Belleville	17x137
13	Washer	17x124
14	Bolt, Hex	1x142
15	Blade, Side Discharge	42225E701
16	Adapter, Blade	71056
17	Height Adjuster, Right Front (8" Wheels)	672600
	Height Adjuster, Right Front (7" Wheels)	672634
18	Height Adjuster, Right Rear (8" Wheels)	672640
	Height Adjuster, Right Rear (7" Wheels)	672636
19	Guard, Rear	672738
20	Screw	26x245
21	Deflector, Chute	672421
22	Push-On Cap	28x42
23	Pin, Pivot	215x11 Z
24	Spring	166x5
27	Bracket, Left Handle	1101303E700
28	Bracket, Right Handle	1101302E700
-	Book, Instruction	F-030401L

‡ Parts are available from an Authorized Engine Service Center. See "Engines, Gasoline" or "Gasoline Engines" in the yellow pages of the telephone directory.

See the "Wheel And Tire Parts List" page.

WHEELS AND TIRES

Look at the illustration of the wheels and tires you want. Then choose the correct wheel and tire from the following choices.

A

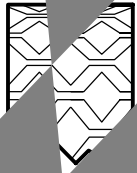

B

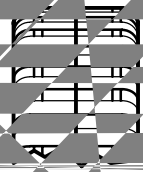



Use extreme ca
slopes. Operat
of slopes, nevi

On a riding mower to dete
slope. If you can back up t
and do not mow a slope th
do not operate the unit on
A 15 degree slope is a hill
A 10 degree slope is a hill



HOW TO ORDER REPAIR PARTS

Only use a factory repair part. Repair parts, except for the engine or the transmission, are available from the store where the unit was purchased, a service shop recommended by the store, or an authorized service shop found in the yellow pages of the telephone directory. If you cannot get a repair part or service as described above, call or write to the Central Parts Distributor shown below. When you order, include the following information: (1) Complete Model Number (see nameplate), (2) Date of Manufacture, (3) Complete Part Number, (4) Description, (5) Quantity.

Repair parts for the engine or the transmission are available from the manufacturer's authorized service center found in the yellow pages of the telephone directory. See the individual engine or transmission warranties.

MURRAY, INC. LAWN MOWER CENTRAL PARTS DISTRIBUTORS

BEBCO, INC.

2221 2nd. Ave.
South Birmingham, AL. 35233
(205)251-4600 1-800-828-8094

**Alabama, Florida, Georgia,
Puerto Rico**

BILLIQU'S, INC.

1343 South Main St.
Porterville, CA. 93257
(559)784-4102 1-877-245-5468
FAX 1-800-266-7337

**Arizona, California, Hawaii,
Nevada**

BROWN & WISER, INC.

9991 S.W. Avery Street
P.O. Box 1109
Tualatin, OR. 97062
(503)692-0330 1-800-882-4782

Alaska, Idaho (counties Ada, Adams, Benewah, Boise, Bonner, Bounding, Canyon, Clearwater, Elmore, Gem, Idaho, Kooten, Latah, Lewis, NEZ Perce, Owyhee, Payette, Ravalli, Shoshone, Valley, Washington), **Montana** (counties Flathead, Lake, Lincoln, Mineral, Missoula, Ravalli, Sanders), **Oregon, Washington**

CPT CANADA POWER TECHNOLOGY LIMITED

161 Watline Avenue
Mississauga, Ontario
L4Z-1P2
(905)890-6900 1-800-861-9559

101-10411-178 Street
Edmonton, Alberta
T5S 1R5
(780)453-5791 1-800-861-9559

234 Mignerion Street
Ville St-Laurent, Quebec
H4T 1Y7
(514)731-3559 1-800-861-9559
Canada

ENGINES SOUTHWEST

1255 North Hearne
Shreveport, LA. 71107

PO Box 67
Shreveport, LA. 71161
(318)222-3871 1-800-388-6995
www.enginesw.com

Arkansas (except these counties: Clay, Craighead, Crittendan, Cross, Greene, Hempstead, Howard, Jackson, Lafayette, Lawrence, Lee, Little River, Miller, Mississippi, Monroe, Nevada, Phillips, Pike, Poinsett, Randolph, Sevier, St. Francis, Woodruff) **Louisiana, Mississippi** (except these counties: Desota, Panola, Quitman Tate, Tunica.)

FRANK EDWARDS CO.

3626 Parkway Blvd.
West Valley City, UT 84120
(801)736-8060 1-800-318-0201
FAX 1-800-570-0491

Colorado, Idaho (counties Bannock Bearlake, Bingham, Blaine, Booneville, Butte, Camas, Caribou, Cassia, Custer, Franklin, Fremont, Gooding, Jefferson, Jerome, Lemhi, Lincoln, Madison, Minidoka, Oneida, Power, Teton, Twin Falls) **Montana** (all counties except Brown and Wiser), **Utah, Wyoming**

GARDNER, INC.

1150 Chesapeake Ave.
Columbus, OH. 43212
(614)488-7951 1-800-848-8946

Arkansas (counties Clay, Craighead, Crittendan, Cross, Greene, Jackson, Lawrence, Lee, Mississippi, Monroe, Phillips, Poinsett, Randolph, St. Francis, Woodruff), **Indiana, Kentucky, Michigan** (except upper Peninsula), **Mississippi** (counties Desota, Panola, Quitman, Tate, Tunica), **Ohio, Western Pennsylvania** with zip codes up to and including 16999, **Tennessee, West Virginia**

GULF COAST ENGINE, INC.

4202 Russell Dr.
P.O. Box 9724
Corpus Christi, TX. 78408
(361)888-6999 1-800-825-6999
Arkansas (counties Hempstead, Howard, Lafayette, Little River, Miller, Nevada, Pike, Sevier) **New Mexico, Oklahoma, Texas, Mexico**

OSCAR WILSON ENGINE & PARTS

826 Lone Star Dr.
O'Fallon, MO. 63366
(314)978-1313 1-800-873-6722
Illinois (S. of Hwy. 80), **Iowa, Kansas, Missouri, Nebraska**

R.B.I. CORPORATION

P.O. Box 9318
Richmond, VA. 23227
(804)550-2210 1-800-888-7149
FAX 1-800-947-1335
Connecticut, Delaware, District of Columbia, Maine, Maryland, Massachusetts, New Hampshire, New Jersey, New York, N. & S. Carolina, Pennsylvania zips 17000 & up, **Rhode Island, Vermont, Virginia**

WISCONSIN MAGNETO

4727 N. Teutonia Ave.
Milwaukee, WI. 53209
(414)445-2800 1-800-733-7388
Illinois (N. of Hwy. 80), **Michigan** (upper Peninsula), **Wisconsin**

800 McKinley St.
Anoka, MN. 55303
(612)323-7477 1-800-248-4016
Minnesota, North & South Dakota